

Panasonic®

Operating Instructions Basic Guide

FULL HD LCD Display For business use

English

Model No.	TH-55SF1HU	55-inch model
	TH-49SF1HU	49-inch model
	TH-42SF1HU	42-inch model
	TH-55SF1HW	55-inch model
	TH-49SF1HW	49-inch model
	TH-42SF1HW	42-inch model

Contents

Important Safety Instructions	2
FCC STATEMENT	3
Important Safety Notice	4
Safety Precautions	5
Precautions for use	8
Feature of This Unit	10
Accessories	10
Connections	12
Identifying Controls	15
Basic Controls	17
Specifications	19
Software License	22
Panasonic Professional Flat Panel Display Limited Warranty	23
LIMITED WARRANTY STATEMENT	24
Customer Service	25



For more detailed instructions, refer to the
Operating Instructions on the CD-ROM.

- Please read these instructions before operating your set and retain them for future reference.
- Illustrations and screens in this Operating Instructions are images for illustration purposes, and may be different from the actual ones.
- Descriptive illustrations in this Operating Instructions are created mainly based on the 55-inch model.



HDMI

DPQX1125ZA

**WARNING: RISK OF ELECTRIC SHOCK
DO NOT OPEN**



WARNING: To reduce the risk of electric shock, do not remove cover or back.

No user-serviceable parts inside. Refer servicing to qualified service personnel.



The lightning flash with arrow-head within a triangle is intended to tell the user that parts inside the product are a risk of electric shock to persons.



The exclamation point within a triangle is intended to tell the user that important operating and servicing instructions are in the papers with the appliance.

WARNING:

To prevent damage which may result in fire or shock hazard, do not expose this apparatus to rain or moisture.

Do not place containers with water (flower vase, cups, cosmetics, etc.) above the set. (including on shelves above, etc.)

WARNING:

- 1) To prevent electric shock, do not remove cover. No user serviceable parts inside. Refer servicing to qualified service personnel.
- 2) Do not remove the grounding pin on the power plug. This apparatus is equipped with a three pin grounding-type power plug. This plug will only fit a grounding-type power outlet. This is a safety feature. If you are unable to insert the plug into the outlet, contact an electrician.
Do not defeat the purpose of the grounding plug.

Important Safety Instructions

- 1) Read these instructions.
- 2) Keep these instructions.
- 3) Heed all warnings.
- 4) Follow all instructions.
- 5) Do not use this apparatus near water.
- 6) Clean only with dry cloth.
- 7) Do not block any ventilation openings. Install in accordance with the manufacturer's instructions.
- 8) Do not install near any heat sources such as radiators, heat registers, stoves, or other apparatus (including amplifiers) that produce heat.
- 9) Do not defeat the safety purpose of the polarized or grounding-type plug. A polarized plug has two blades with one wider than the other. A grounding type plug has two blades and a third grounding prong. The wide blade or the third prong are provided for your safety. If the provided plug does not fit into your outlet, consult an electrician for replacement of the obsolete outlet.
- 10) Protect the power cord from being walked on or pinched particularly at plugs, convenience receptacles, and the point where they exit from the apparatus.
- 11) Only use attachments / accessories specified by the manufacturer.
- 12) Use only with the cart, stand, tripod, bracket, or table specified by the manufacturer, or sold with the apparatus. When a cart is used, use caution when moving the cart / apparatus combination to avoid injury from tip-over. 
- 13) Unplug this apparatus during lightning storms or when unused for long periods of time.
- 14) Refer all servicing to qualified service personnel. Servicing is required when the apparatus has been damaged in any way, such as power-supply cord or plug is damaged, liquid has been spilled or objects have fallen into the apparatus, the apparatus has been exposed to rain or moisture, does not operate normally, or has been dropped.
- 15) To prevent electric shock, ensure the grounding pin on the AC cord power plug is securely connected.

FCC STATEMENT

This equipment has been tested and found to comply with the limits for a class A digital device, pursuant to Part 15 of the FCC Rules. These limits are designed to provide reasonable protection against harmful interference when the equipment is operated in a commercial environment. This equipment generates, uses and can radiate radio frequency energy and, if not installed and used in accordance with the instructions manual, may cause harmful interference to radio communications. Operation of this equipment in a residential area is likely to cause harmful interference in which case the user will be required to correct the interference at his own expense.

FCC CAUTION:

To assure continued compliance, follow the attached installation instructions and use only the provided power supply cord. Any changes or modifications not expressly approved by Panasonic Corp. of North America could void the user's authority to operate this device.

Declaration of Verification

Model No.

TH-55SF1HU, TH-49SF1HU, TH-42SF1HU

Responsible Party:

Panasonic Corporation of North America
Two Riverfront Plaza, Newark, New Jersey
07102-5490

Contact Source:

Panasonic System Communications Company of
North America
1-877-655-2357

General Contact:

<http://shop.panasonic.com/support>

This device complies with Part 15 of the FCC Rules and all applicable IC RSS standards. Operation is subject to the following two conditions: (1) This device may not cause harmful interference, and (2) this device must accept any interference received, including interference that may cause undesired operation.

CANADIAN NOTICE:

This Class A digital apparatus complies with Canadian ICES-003.

WARNING:

- Not for use in a computer room as defined in the Standard for the Protection of Electronic Computer/Data Processing Equipment, ANSI/NFPA 75.
- For permanently connected equipment, a readily accessible disconnect device shall be incorporated in the building installation wiring.
- For pluggable equipment, the socket-outlet shall be installed near the equipment and shall be easily accessible.

Note:

Image retention may occur. If you display a still picture for an extended period, the image might remain on the screen. However, it will disappear when a general moving picture is displayed for a while.

Trademark Credits

- Microsoft, Windows, Windows Vista and Internet Explorer are the registered trademarks or trademarks of Microsoft Corporation in the United States and/or other countries.
- Macintosh, Mac, Mac OS, OS X and Safari are the trademarks of Apple Inc. registered in the United States and other countries.
- PJLink is a registered or pending trademark in Japan, the United States, and other countries and regions.
- HDMI, the HDMI Logo, and High-Definition Multimedia Interface are trademarks or registered trademarks of HDMI Licensing LLC in the United States and other countries.
- JavaScript is a registered trademark or a trademark of Oracle Corporation and its subsidiary and associated companies in the United States and/or other countries.
- RoomView, Crestron RoomView and Fusion RV are registered trademarks of Crestron Electronics, Inc. Crestron Connected is the trademark of Crestron Electronics, Inc.

Even if no special notation has been made of company or product trademarks, these trademarks have been fully respected.

Important Safety Notice

WARNING

- 1) To prevent damage which may result in fire or shock hazard, do not expose this appliance to dripping or splashing.
Do not place containers with water (flower vase, cups, cosmetics, etc.) above the set. (including on shelves above, etc.)
No naked flame sources, such as lighted candles, should be placed on / above the set.
- 2) To prevent electric shock, do not remove cover. No user serviceable parts inside. Refer servicing to qualified service personnel.
- 3) Do not remove the earthing pin on the power plug. This apparatus is equipped with a three pin earthing-type power plug. This plug will only fit an earthing-type power outlet. This is a safety feature. If you are unable to insert the plug into the outlet, contact an electrician.
Do not defeat the purpose of the earthing plug.
- 4) To prevent electric shock, ensure the earthing pin on the AC cord power plug is securely connected.

CAUTION

This appliance is intended for use in environments which are relatively free of electromagnetic fields.

Using this appliance near sources of strong electromagnetic fields or where electrical noise may overlap with the input signals could cause the picture and sound to wobble or cause interference such as noise to appear.

To avoid the possibility of harm to this appliance, keep it away from sources of strong electromagnetic fields.

WARNING:

This equipment is compliant with Class A of CISPR32. In a residential environment this equipment may cause radio interference.

IMPORTANT INFORMATION

If a display is not positioned in a sufficiently stable location, it can be potentially hazardous due to falling. Many injuries, particularly to children, can be avoided by taking simple precautions such as:

- Using cabinets or stands recommended by the manufacturer of the display.
- Only using furniture that can safely support the display.
- Ensuring the display is not overhanging the edge of the supporting furniture.
- Not placing the display on tall furniture (for example, cupboards or bookcases) without anchoring both the furniture and the display to a suitable support.
- Not standing the displays on cloth or other materials placed between the display and supporting furniture.
- Educating children about the dangers of climbing on furniture to reach the display or its controls.

Safety Precautions

IMPORTANT: THE MOULDED PLUG FOR YOUR SAFETY, PLEASE READ THE FOLLOWING TEXT CAREFULLY.

This display is supplied with a moulded three pin mains plug for your safety and convenience. A 10 amp fuse is fitted in this plug. Shall the fuse need to be replaced, please ensure that the replacement fuse has a rating of 10 amps and that it is approved by ASTA or BSI to BS1362.

Check for the ASTA mark  or the BSI mark  on the body of the fuse.

If the plug contains a removable fuse cover, you must ensure that it is refitted when the fuse is replaced.

If you lose the fuse cover the plug must not be used until a replacement cover is obtained.

A replacement fuse cover can be purchased from your local Panasonic dealer. Do not cut off the mains plug.

Do not use any other type of mains lead except the one supplied with this display.

The supplied mains lead and moulded plug are designed to be used with this display to avoid interference and for your safety.

If the socket outlet in your home is not suitable, get it changed by a qualified electrician.

If the plug or mains lead becomes damaged, purchase a replacement from an authorized dealer.

WARNING : — THIS DISPLAY MUST BE EARTHED.

How to replace the fuse.

Open the fuse compartment with a screwdriver and replace the fuse.

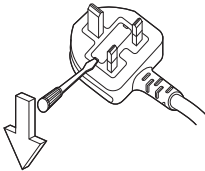

WARNING

■ Setup

This LCD Display is for use only with the following optional accessories.

Use with any other type of optional accessories may cause instability which could result in the possibility of injury.

(All of the following accessories are manufactured by Panasonic Corporation.)

- Pedestal
TY-ST43PE8
- Digital Interface Box
ET-YFB100G
- DIGITAL LINK Switcher
ET-YFB200G
- Early Warning Software
ET-SWA100 series*1
- Video Wall Manager
TY-VUK10*2

*1: Suffix of the part number may differ depending on the license type.

*2: Supports Ver1.3 or later.

Note

- The part number of the optional accessories are subject to change without notice.

When installing the pedestal, read the operating instructions supplied with it carefully and install properly.

Also, always use the overturn prevention accessories.

We are not responsible for any product damage, etc. caused by failures in the installation environment for the pedestal or wall-hanging bracket even during the warranty period.

Always be sure to ask a qualified technician to carry out set-up.

Small parts can present choking hazard if accidentally swallowed. Keep small parts away from young children. Discard unneeded small parts and other objects, including packaging materials and plastic bags/sheets to prevent them from being played with by young children, creating the potential risk of suffocation.

Do not place the Display on sloped or unstable surfaces, and ensure that the Display does not hang over the edge of the base.

- The Display may fall off or tip over.

Install this unit at a location with minimal vibration and which can support the weight of the unit.

- Dropping or falling of the unit may cause injury or malfunction.

Do not place any objects on top of the Display.

- If foreign objects or water get inside the Display, a short-circuit may occur which could result in fire or electric shock. If any foreign objects get inside the Display, please consult your local Panasonic dealer.

Transport only in upright position!

- Transporting the unit with its liquid crystal panel facing upright or downward may cause damage to the internal circuitry.

Ventilation should not be impeded by covering the ventilation openings with items such as newspapers, table cloths and curtains.

For sufficient ventilation, see page 8.

Caution - For use only with UL Listed Wall Mount Bracket with minimum weight/load 24.9 kg (54.9 lbs).

When installing the Display vertically;

When installing the Display vertically, be sure that the Power Indicator comes to the downside. Heat is generated and it may cause fire or damage to the Display.

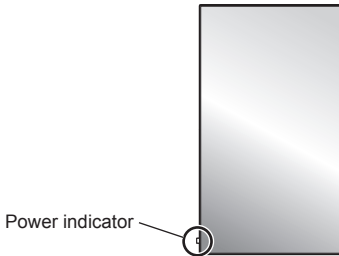

Cautions for Wall or Pedestal Installation

- The installation should be performed by an installation professional. Installing the Display incorrectly may lead to an accident that results in death or serious injury.

Use the optional Pedestal. (see page 5)

- When installing on a wall, a wall hanging bracket that conforms to VESA standards must be used.

55-inch model (49-inch model) : VESA 400×400

42-inch model : VESA 200×200

(see page 8)

- Before installation, be sure to check if the mounting location has enough strength to support the weight of the LCD display and the wall hanging bracket for anti drop.
- If you terminate the use of the Display on the Wall or Pedestal, ask a professional to remove the Display as soon as possible.
- When mounting the Display on the wall, prevent the mounting screws and power cable from contacting metal objects inside the wall. An electric shock may occur if they contact metal objects inside the wall.

Do not install the product to a place where the product is exposed to direct sunlight.

- If the screen is exposed to direct sunlight, the liquid crystal panel may have adverse effect.

■ When using the LCD Display

The Display is designed to operate on 110 – 127 or 220 – 240 V AC, 50/60 Hz.

Do not cover the ventilation holes.

- Doing so may cause the Display to overheat, which can cause fire or damage to the Display.

Do not stick any foreign objects into the Display.

- Do not insert any metal or flammable objects into the ventilations holes or drop them onto the Display, as doing so can cause fire or electric shock.

Do not remove the cover or modify it in any way.

- High voltages which can cause severe electric shocks are present inside the Display. For any inspection, adjustment and repair work, please contact your local Panasonic dealer.

Ensure that the mains plug is easily accessible.

The mains plug shall be connected to a mains socket outlet with a protective earthing connection.

Do not use any power supply cord other than that provided with this unit.

- Doing so may cause short-circuit, generates heat, etc., which could cause electric shock or fire.

Do not use the supplied power supply cord with any other devices.

- Doing so could cause electric shock or fire.

Securely insert the power supply plug as far as it will go.

- If the plug is not fully inserted, heat may be generated which could cause fire. If the plug is damaged or the wall socket is loose, they shall not be used.

Do not handle the power supply plug with wet hands.

- Doing so may cause electric shocks.

Do not do anything that may damage the power cable. When disconnecting the power cable, pull on the plug body, not the cable.

- Do not damage the cable, make any modifications to it, place heavy objects on top of it, heat it, place it near any hot objects, twist it, bend it excessively or pull it. To do so may cause fire and electric shock. If the power cable is damaged, have it repaired at your local Panasonic dealer.

Do not touch the power supply cord or the plug directly by hand when they are damaged.

- Electric shock could occur.

Do not remove covers and NEVER modify the Display yourself

- Do not remove the rear cover as live parts are accessible when it is removed. There are no user serviceable parts inside. (High-voltage components may cause serious electrical shock.)
- Have the Display checked, adjusted, or repaired at your local Panasonic dealer.

Keep the supplied AAA/R03/UM4 batteries out of reach of children. If accidentally swallowed, it will be harmful to the body.

- Please contact a doctor immediately in case you doubt that the child may have swallowed it.

If the Display is not going to be used for any prolonged length of time, unplug the power supply plug from the wall outlet.

Picture noise may occur if you connect / disconnect the cables connected to the input terminals you are currently not watching, or if you turn the power of the video equipment on / off, but it is not a malfunction.

To prevent the spread of fire, keep candles or other open flames away from this product at all times.



CAUTION

If problems or malfunction occur, stop using immediately.

■ If problems occur, unplug the power supply plug.

- Smoke or an abnormal odour come out from the unit.
- No picture appears or no sound is heard, occasionally.
- Liquid such as water or foreign objects got inside the unit.
- The unit has deformed or broken parts.

If you continue to use the unit in this condition, it could result in fire or electric shock.

- Turn the power off immediately, unplug the power supply plug from the wall outlet, and then contact the dealer for repairs.
- To cut off the power supply to this Display completely, you need to unplug the power supply plug from the wall outlet.
- Repairing the unit yourself is dangerous, and shall never be done.
- To enable to unplug the power supply plug immediately, use the wall outlet which you can reach easily.

■ Do not touch the unit directly by hand when it is damaged.

Electric shock could occur.

■ When using the LCD Display

Do not bring your hands, face or objects close to the ventilation holes of the Display.

- Heated air comes out from the ventilation holes at the top of Display will be hot. Do not bring your hands or face, or objects which cannot withstand heat, close to this port, otherwise burns or deformation could result.

At least 2 people are required to carry or unpack this unit.

- If this is not observed, the unit may drop, resulting in injury.

Be sure to disconnect all cables before moving the Display.

- If the Display is moved while some of the cables are still connected, the cables may become damaged, and fire or electric shock could result.

Disconnect the power supply plug from the wall socket as a safety precaution before carrying out any cleaning.

- Electric shocks can result if this is not done.

Clean the power cable regularly to prevent it becoming dusty.

- If dust built up on the power cord plug, the resultant humidity can damage the insulation, which could result in fire. Pull the power cord plug out from the wall outlet and wipe the mains lead with a dry cloth.

Do not step on, or hang from the display or the Pedestal.

- They might tip over, or might be broken and it may result in injury. Pay special attention to the children.

Do not reverse the polarity (+ and -) of the battery when inserting.

- Mishandling the battery may cause its explosion or leakage, resulting in fire, injury or damage to surrounding properties.
- Insert the battery correctly as instructed. (see page 11)

Remove the batteries from the remote control transmitter when not using for a long period of time.

- The battery may leak, heat, ignite or burst, resulting in fire or damage to surrounding properties.

Do not burn or breakup batteries.

- Batteries must not be exposed to excessive heat such as sunshine, fire or the like.

Do not turn the Display upside down.

Do not position the unit with its liquid crystal panel facing upright.

Precautions for use

Cautions when installing

Do not set up the Display outdoors.

- The Display is designed for indoor use.

Environmental temperature to use this unit

- When using the unit where it is below 1 400 m (4 593 ft) above sea level: 0 °C to 40 °C (32 °F to 104 °F)
- When using the unit at high altitudes (1 400 m (4 593 ft) and higher and below 2 800 m (9 186 ft) above sea level): 0 °C to 35 °C (32 °F to 95 °F)

Do not install the unit where it is 2 800 m (9 186 ft) and higher above sea level.

- Failure to do so may shorten the life of the internal parts and result in malfunctions.

Required space for ventilation

When using the pedestal (optional accessory), leave a space of 10 cm (3 15/16") or more at the top, left and right, and 5 cm (1 31/32") or more at the rear, and also keep the space between the bottom of the display and the floor surface.

If using some other setting-up method (wall-hanging, etc.), follow the manual of it. (If there is no specific indication of installation dimension in the installation manual, leave a space of 10 cm (3 15/16") or more at the top, bottom, left and right, and 5 cm (1 31/32") or more at the rear.)

Minimum distance:

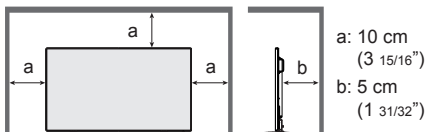

About the screws used when using a wall hanging bracket that conforms to VESA standards

Inch model	Screw pitch for installation	Depth of screw hole	Screw (quantity)
55	400 mm × 400 mm	10 mm	M6 (4)
49	400 mm × 400 mm	10 mm	M6 (4)
42	200 mm × 200 mm	10 mm	M6 (4)

When installing, do not use the screw holes (situated at the bottom of the display's back) as shown in the following figures.

It may damage the LCD panel.

55-inch model



49-inch model



42-inch model



Be careful of the movable structure of the power indicator and remote control sensor.

- As factory default, the power indicator and remote control sensor are stored in the main unit. For normal use, pull out the remote control sensor from the edge side of the main unit by operating the lever on the rear panel. Depending on the setup condition such as when using the multi display, store the remote control sensor in the main unit. (see page 15)

Do not grab the liquid crystal panel.

- Do not forcibly press the liquid crystal panel, or push it with a pointed object. Applying a strong force to the liquid crystal panel will cause unevenness of the screen display, resulting in malfunction.

Depending on the temperature or humidity conditions, uneven brightness may be observed. This is not a malfunction.

- This unevenness will disappear while applying current continuously. If not, consult the distributor.

Request Regarding Security

When using this product, take safety measures against the following incidents.

- Personal information being leaked via this product
- Unauthorized operation of this product by a malicious third party
- Interfering or stopping of this product by a malicious third party

Take sufficient security measures.

- Set a password for the LAN control and restrict the users who can log in.
- Make your password difficult to guess as much as possible.
- Change your password periodically.
- Panasonic Corporation or its affiliate companies will never ask for your password directly. Do not divulge your password in case you receive such inquiries.
- The connecting network must be secured by a firewall, etc.
- When disposing the product, initialize the data before disposing.

[Shipping]

Cleaning and maintenance

The front of the liquid crystal panel has been specially treated. Wipe the surface of the liquid crystal panel gently using only a cleaning cloth or a soft, lint-free cloth.

- If the surface is particularly dirty, wipe with a soft, lint-free cloth which has been soaked in pure water or water in which neutral detergent has been diluted 100 times, and then wipe it evenly with a dry cloth of the same type until the surface is dry.
- Do not scratch or hit the surface of the panel with fingernails or other hard objects, otherwise the surface may become damaged. Furthermore, avoid contact with volatile substances such as insect sprays, solvents and thinner, otherwise the quality of the surface may be adversely affected.

If the cabinet becomes dirty, wipe it with a soft, dry cloth.

- If the cabinet is particularly dirty, soak the cloth in water to which a small amount of neutral detergent has been added and then wring the cloth dry. Use this cloth to wipe the cabinet, and then wipe it dry with a dry cloth.
- Do not allow any detergent to come into direct contact with the surface of the Display. If water droplets get inside the unit, operating problems may result.
- Avoid contact with volatile substances such as insect sprays, solvents and thinner, otherwise the quality of the cabinet surface may be adversely affected or the coating may peel off. Furthermore, do not leave it for long periods in contact with articles made from rubber or PVC.

Usage of a chemical cloth

- Do not use a chemical cloth for the panel surface.
- Follow the instructions for the chemical cloth to use it for the cabinet.

Wired LAN

When setting up the Display at a place, where electric static occurs often, take a sufficient anti-static measure before start using.

- When the Display is used at a location, where static electricity occurs often, such as on a carpet, communications of the wired LAN or DIGITAL LINK are disconnected more often. In that case, remove static electricity and the noise source that may cause problems with an antistatic mat, and re-connect the wired LAN or DIGITAL LINK.
- In rare cases, the LAN connection is disabled due to static electricity or noise. In that case, turn off the power of the Display and the connected devices once and then re-turn on the power.

The Display may not work properly due to strong radio wave from the broadcast station or the radio.

- If there is any facility or equipment, which outputs strong radio wave, near the installation location, set up the Display at a location sufficiently far from the source of the radio wave. Or, wrap the LAN cable connected to the DIGITAL LINK / LAN terminal by using a piece of metal foil or a metal pipe, of which is grounded at both ends.

Disposal

When disposing the product, ask your local authority or dealer about the correct methods of disposal.

Feature of This Unit

- This unit has a function to send the ID signal (hereafter referred to as [LightID], ID = Identifier) that represents a variety of information by blinking the LED light source (Backlight) rapidly. This allows the unit to send a variety of information to devices, such as a smartphone.

Accessories

Accessories Supply

Check that you have the accessories and items shown

Operating Instructions (CD-ROM × 1)

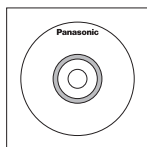

Remote Control Transmitter × 1

- N2QAYA000099



Batteries for the Remote Control Transmitter

(AAA/R03/UM4 type × 2)

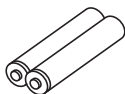

Clamper × 3

- DPVF1056ZA

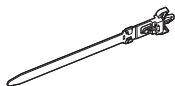

Power supply cord

(Approx. 2 m)

TH-55SF1HU

TH-49SF1HU

TH-42SF1HU

- 1JP155AF1U

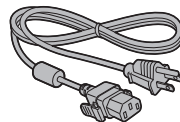

TH-55SF1HW

TH-49SF1HW

TH-42SF1HW

- 1JP155AF1W

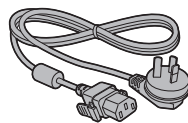

- 2JP155AF1W

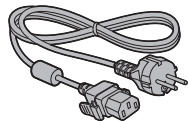

- 3JP155AF1W

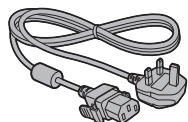

Attention

- Store small parts in an appropriate manner, and keep them away from young children.
- The part numbers of accessories are subject to change without notice. (The actual part number may differ from the ones shown above.)
- In case you lost accessories, please purchase them from your dealer. (Available from the customer service)
- Dispose the packaging materials appropriately after taking out the items.

Remote Control Batteries

1. Pull and hold the hook, then open the battery cover.

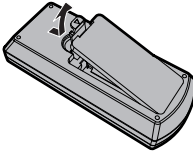

2. Insert batteries - note correct polarity (+ and -).

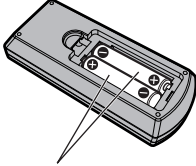

AAA/R03/UM4 type

3. Replace the cover.

Helpful Hint

- For frequent remote control users, replace old batteries with Alkaline batteries for longer life.



Precaution on battery use

Incorrect installation of the batteries can cause battery leakage and corrosion that will damage the remote control transmitter.

Disposal of batteries should be in an environment-friendly manner.

Observe the following precaution:

1. Batteries shall always be replaced as a pair. Always use new batteries when replacing the old set.
2. Do not combine a used battery with a new one.
3. Do not mix battery types (example: "Zinc Carbon" with "Alkaline").
4. Do not attempt to charge, short-circuit, disassemble, heat or burn used batteries.
5. Battery replacement is necessary when remote control acts sporadically or stops operating the Display set.
6. Do not burn or breakup batteries.
7. Batteries must not be exposed to excessive heat such as sunshine, fire or the like.

Kensington security

The security slot of this unit is compatible with the Kensington security slot.

55-inch model

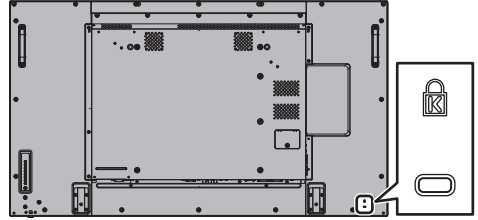

49-inch model

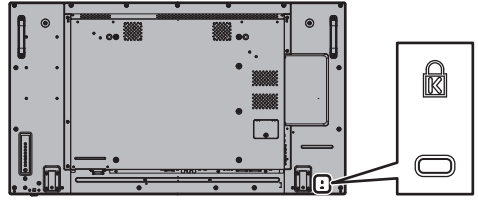

42-inch model

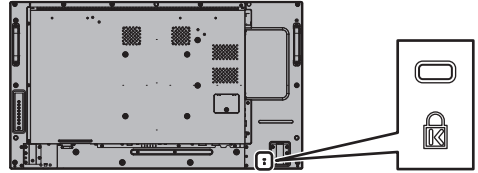

Connections

AC cord connection and fixing

Back of the unit

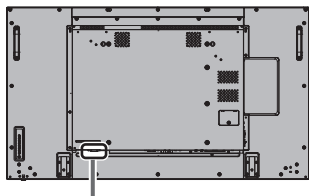

AC cord fixing

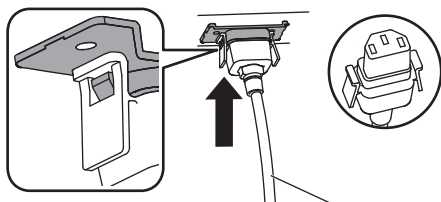

AC cord (supplied)

Plug the connector into the display unit.

Plug the connector until it clicks.

Note

- Make sure that the connector is locked on both the left and right sides.

Unplug the AC cord

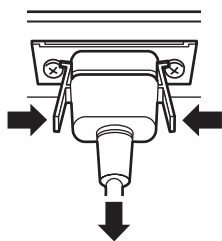

Unplug the connector pressing the two knobs.

Note

- When disconnecting the AC cord, be absolutely sure to disconnect the AC cord plug at the socket outlet first.
- The supplied AC cord is for this unit exclusive use. Do not use this for other purposes.

Cable fixing

Note

- 3 clampers are supplied with this unit. Fix the cables at 3 locations using the holes for clampers as shown below.

If you need more clampers, purchase them from your dealer. (Available from the customer service)

55-inch model

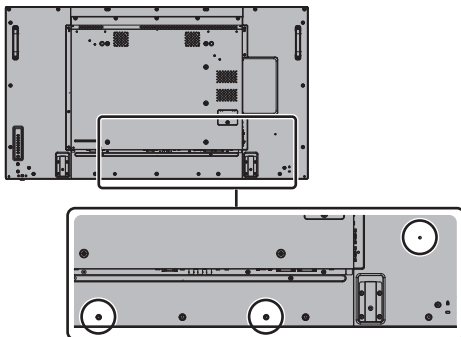

- The positions of the holes are the same for 42-inch and 49-inch models.

1. Attach the clamer

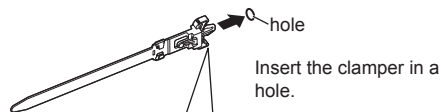

Insert the clamer in a hole.

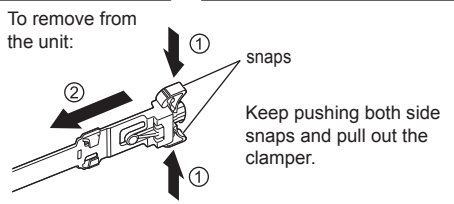

To remove from the unit:

snaps

Keep pushing both side snaps and pull out the clamer.

2. Bundle the cables

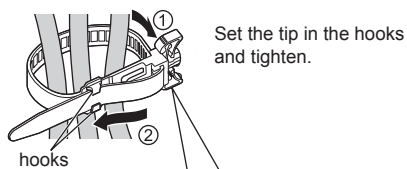

Set the tip in the hooks and tighten.

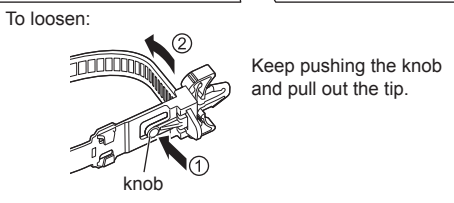

To loosen:

Keep pushing the knob and pull out the tip.

Video equipment connection

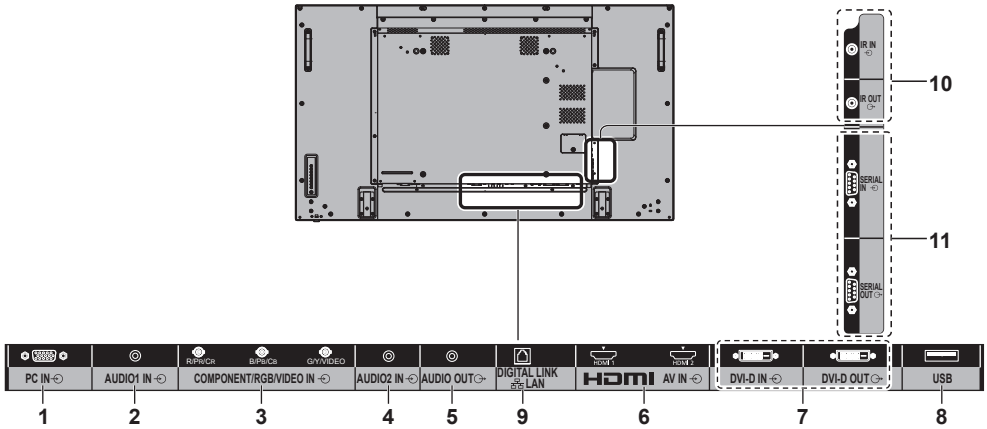

1 PC IN:	PC Input Terminal Connect to video terminal of PC, video equipment with "YPbPr / YCbCr" or "RGB" output.
2 AUDIO1 IN:	Audio input terminal shared with DVI-D IN and PC IN
3 COMPONENT / RGB / VIDEO IN:	COMPONENT / RGB Video Input Terminal (R/Pr/Cr, B/Pb/Cb, G/Y) Connect to video equipment with "YPbPr / YCbCr" or "RGB" output. Composite Video Input Terminal (VIDEO) Connect to video equipment with Composite signal output.
4 AUDIO2 IN:	Audio Input Terminal shared with COMPONENT/RGB IN and VIDEO IN
5 AUDIO OUT:	Analogue Audio Output Terminal Connect to audio equipment with analogue audio input terminal.
6 AV IN (HDMI 1, HDMI 2):	HDMI Input Terminal Connect to video equipment such as VCR or DVD player, etc.

7 DVI-D IN, DVI-D OUT:	DVI-D Input / Output Terminal Connect to video equipment with DVI-D output. Also, when displaying the picture by daisy chaining multiple displays, connect to the other display (DVI-D OUT). The DVI-D output function is enabled only when the picture is displayed via DVI-D IN.
8 USB:	USB Terminal Connect the USB memory to use [USB media player]. Also, this can be used to supply power of up to 5V/1A to an external device when the picture is displayed.
9 DIGITAL LINK / LAN:	DIGITAL LINK Input / LAN Terminal Connect to a device that sends video and audio signals via the DIGITAL LINK terminal. Alternatively, control the Display by connecting to Network.
10 IR IN, IR OUT:	Infrared Signal Input / Output Terminal Use this when operating more than one display with one remote control.

11 SERIAL IN, SERIAL OUT:	SERIAL Input / Output Terminal Control the Display by connecting to PC.
--------------------------------------	---

Before connecting

- Before connecting cables, carefully read the operating instructions for the external device to be connected.
- Turn off the power of all devices before connecting cables.
- Take note of the following points before connecting the cables. Failure to do so may result in malfunctions.
 - When connecting a cable to the unit or a device connected to the unit or to the unit body, touch any nearby metallic objects to eliminate static electricity from your body before performing work.
 - Do not use unnecessarily long cables to connect a device to the unit or to the unit body. The longer the cable, the more susceptible to noise it becomes. Since using a cable while it is wound makes it act like an antenna, it is more susceptible to noise.
 - When connecting cables, connect GND first, then insert the connecting terminal of the connecting device in a straight manner.
- Acquire any cable necessary to connect the external device to the system that is neither supplied with the device nor available as an option.
- If the outer shape of the plug of a connection cable is large, it may come in contact with the periphery such as a back cover or the plug of an adjacent connection cable. Use a connection cable with the suitable plug size for the terminal alignment.
- If video signals from video equipment contain too much jitter, the images on the screen may wobble. In this case, a time base corrector (TBC) must be connected.
- When the sync signals output from PC or video equipment are disturbed, for example, when changing settings of video output, the colour of the video may be disturbed temporarily.
- The unit accepts Composite video signals, YCbCr/YPbPr signals, analogue RGB signals and digital signals.
- Some PC models are not compatible with the unit.
- Use cable compensator when you connect devices to the unit using long cables. Otherwise the image may not display properly.

Identifying Controls

Main Unit

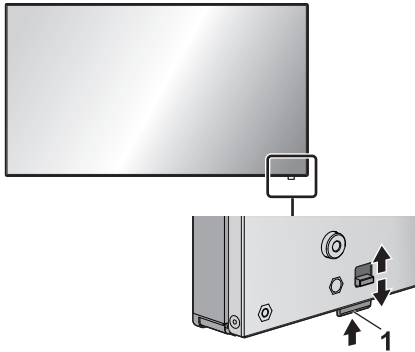

- To take out/store the power indicator and remote control sensor, operate the lever on the rear panel. It is also possible to press the remote control sensor directly to store.

Note

- For normal use, pull out the power indicator and remote control sensor from the edge side of the main unit by operating the lever on the rear panel. Depending on the setup condition such as when using the multi display, store them in the main unit.

1 Power Indicator / Remote control sensor

The Power Indicator will light.

When the power of the unit is ON (Main Power On / Off button: ON)

- Picture is displayed: Green
- Power OFF (Standby) with remote control:
 - When [Network control] is set to [Off]: Red
 - When [Network control] is set to [On]: Orange (Red/Green)
- Power OFF with "Power management" function: Orange (Red/Green)

When the power of the unit is OFF (Main Power On / Off button: OFF): No light

Note

- The unit will still consume some power as long as the power cord is still inserted into the wall outlet.
- When the power indicator is orange, power consumption during standby is generally larger than that of when the power indicator is red.

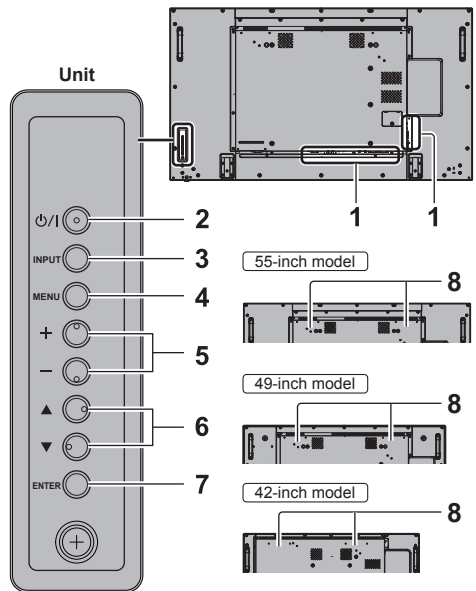

1 External Input / Output Terminal

- Connects to video equipment, PC, etc. (see page 13)

2 <Main Power On / Off button>

- Turns the power On / Off.

3 <INPUT (Unit)> (INPUT signal selection)

- Selects the connected device.

4 <MENU (Unit)>

- Each time the <MENU (Unit)> button is pressed, the menu screen will switch.

5 <+ (Unit)> / <- (Unit)>

- Adjusts the volume.
- On the main screen, switches settings or adjusts settings level.

6 <▲ (Unit)> / <▼ (Unit)>

- Selects the setting item.

7 <ENTER (Unit)>

- Configures the item on menu screen.
- Switches aspect mode.

8 Built-in speakers

Note

- To output sound from the built-in speakers of the unit, be sure to set [Output select] in the [Sound] menu to [SPEAKERS].

Remote Control Transmitter

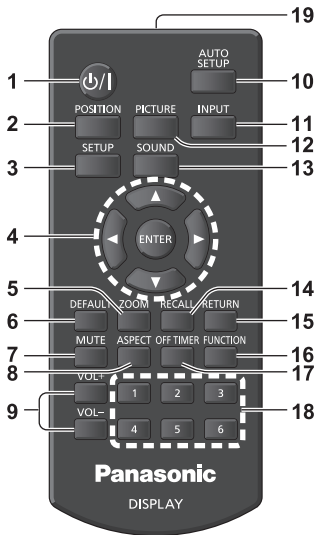

1 Standby (ON/OFF) button (⏻/⏻)

- Turns the power on or off when the Display is turned on at the <Main Power On / Off button>. (see page 17)

2 POSITION

3 SETUP

4 ENTER / Cursor buttons (▲▼◀▶)

- Used to operate the menu screens.

5 ZOOM

Enters the digital zoom mode.

6 DEFAULT

- Resets the settings of picture, sound, etc., to defaults.

7 MUTE

- Sound mute on / off.

8 ASPECT

- Adjusts the aspect.

9 VOL + / VOL -

- Adjusts sound volume level.

10 AUTO SETUP

- Automatically adjusts the position/size of the screen.

11 INPUT

- Switches input to display on the screen.

12 PICTURE

13 SOUND

14 RECALL

- Displays the current setting status of Input mode, Aspect mode, etc.

15 RETURN

- Used to return to the previous menu.

16 FUNCTION

17 OFF TIMER

- Switches to stand-by after a fixed period.

18 Numeric buttons (1 - 6)

- Used as shortcut buttons by assigning frequently used operations.

19 Signal emission

Note

- In this manual, buttons of the remote control and the unit are indicated as < >.

(Example: <INPUT>.)

The operation is mainly explained indicating the remote control buttons but you can also operate with the buttons on the unit when there are the same buttons.

Basic Controls

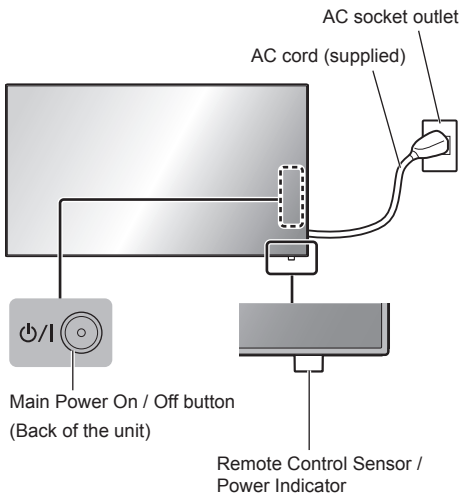

Operate pointing the remote control directly at the unit's Remote Control Sensor.

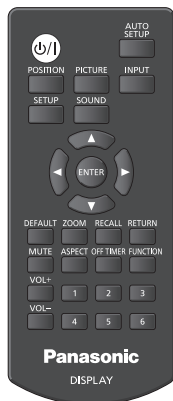

Note

- For normal use, pull out the remote control sensor from the edge side of the main unit by operating the lever on the rear panel. (see page 15)
- Do not put an obstacle between the remote control sensor of the main unit and the remote control.
- Operate the remote control in front of the remote control sensor or from the area where the sensor can be seen.
- When directly aiming the remote control at the remote control sensor of the main unit, the distance from the front of remote control sensor should be approx. 7 m or less. Depending on the angle, the operation distance may be shorter.
- Do not subject the remote control sensor of the main unit to the direct sunlight or strong fluorescent light.

1 Connect the AC cord plug to the Display.

(see page 12)

2 Connect the plug to the socket outlet.

Note

- Main plug types vary between countries. The power plug shown at left may, therefore, not be the type fitted to your set.
- When disconnecting the AC cord, be absolutely sure to disconnect the AC cord plug at the socket outlet first.
- The settings may not be saved if the power plug is disconnected immediately after changing settings with on-screen menu. Disconnect the power plug after a enough period of time. Or, disconnect the power plug after turning the power off with the remote control, RS-232C control or LAN control.

3 Press the <Main Power On / Off button> on the unit to turn the set on: Power-On.

- Power Indicator: Green (Picture is displayed.)
- When the power of the unit is ON, remote control operation is possible.

■ To turn the power ON/OFF with the remote control

Press the <Standby (ON/OFF) button> to turn the Display on.

- Power Indicator: Green (Picture is displayed.)

Press the <Standby (ON/OFF) button> to turn the Display off.

- Power Indicator: Red (standby)

Press the <Main Power On / Off button> on the unit to turn the unit off, when the power of the unit is turned on or in standby mode.

Note

- During operation of the "Power management" function, the power indicator turns orange in the power off state.

■ When the Unit is turned on for the first time

Following screen will be displayed.

1 Select the language with ▲ ▼ and press <ENTER>.



2 Select [Year] / [Month] / [Day] / [Hour] / [Minute] with ▲ ▼ and set with ◀ ▶.

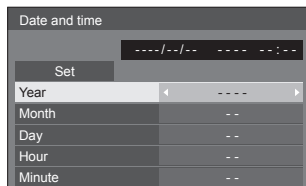

3 Select [Set] with ▲ ▼ and press <ENTER>.

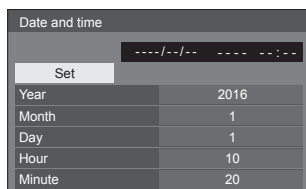

4 For vertical installation, select [Portrait] with ▲ ▼ and press <ENTER>.

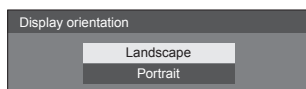

Note

- Once the items are set, the screens won't be displayed when switching on the unit next time. Each item can be reset in the following menus.
[OSD language]
[Date and time]
[Display orientation]

■ Power ON message

The following message may be displayed when turning the unit power ON:

No activity power off Precautions

'No activity power off' is enabled.

When [No activity power off] in the [Setup] menu is set to [Enable], a warning message is displayed every time the power is turned ON.

"Power management" Information

Last turn off due to 'Power management'.

When "Power management" is functioned, an information message is displayed every time the power is turned ON.

These message displays can be set with the following menu:

- [Options] menu
 - Power on message(No activity power off)
 - Power on message(Power management)

Specifications

Model No.

55-inch model : TH-55SF1HU

49-inch model : TH-49SF1HU

42-inch model : TH-42SF1HU

55-inch model : TH-55SF1HW

49-inch model : TH-49SF1HW

42-inch model : TH-42SF1HW

Power Consumption

55-inch model

190 W

49-inch model

175 W

42-inch model

155 W

Power off condition

0.3 W

Stand-by condition

0.5 W

LCD Display panel

55-inch model

55-inch IPS panel (Edge LED backlight), 16:9 aspect ratio

49-inch model

49-inch IPS panel (Edge LED backlight), 16:9 aspect ratio

42-inch model

42-inch IPS panel (Edge LED backlight), 16:9 aspect ratio

Screen size

55-inch model

1 209 mm (W) × 680 mm (H) × 1 387 mm (diagonal) / 47.6" (W) × 26.7" (H) × 54.6" (diagonal)

49-inch model

1 073 mm (W) × 604 mm (H) × 1 232 mm (diagonal) / 42.2" (W) × 23.7" (H) × 48.5" (diagonal)

42-inch model

927 mm (W) × 521 mm (H) × 1 064 mm (diagonal) / 36.5" (W) × 20.5" (H) × 41.9" (diagonal)

Number of pixels

2 073 600 (1 920 (W) × 1 080 (H))

Dimensions (W × H × D)

55-inch model

1 229 mm × 699 mm × 72 mm (57 mm: without handles) / 48.4" × 27.6" × 2.9" (2.3": without handles)

49-inch model

1 093 mm × 623 mm × 72 mm (57 mm: without handles) / 43.1" × 24.6" × 2.9" (2.3": without handles)

42-inch model

947 mm × 541 mm × 72 mm (57 mm: without handles) / 37.3" × 21.3" × 2.9" (2.3": without handles)

Mass

55-inch model

approx. 24.9 kg / 54.9 lbs net

49-inch model

approx. 19.2 kg / 42.4 lbs net

42-inch model

approx. 15.5 kg / 34.2 lbs net

Power source

TH-55SF1HU, TH-49SF1HU, TH-42SF1HU:

110 – 127 V ~ (110 – 127 V alternating current), 50/60Hz

TH-55SF1HW, TH-49SF1HW, TH-42SF1HW:

220 – 240 V ~ (220 – 240 V alternating current), 50/60Hz

Operating condition

Temperature

0 °C to 40 °C (32 °F to 104 °F)*1

Humidity

20 % to 80 % (no condensation)

Storing condition

Temperature

-20 °C to 60 °C (-4 °F to 140 °F)

Humidity

20 % to 80 % (no condensation)

Connection terminals

HDMI 1

HDMI 2

TYPE A Connector*2 × 2

Audio signal:

Linear PCM (sampling frequencies - 48 kHz, 44.1 kHz, 32 kHz)

DVI-D IN

DVI-D 24 Pin × 1:

Compliance with DVI Revision 1.0

Content Protection:

Compatible with HDCP 1.1

DVI-D OUT

DVI-D 24 Pin × 1:

Compliance with DVI Revision 1.0

Content Protection:

Compatible with HDCP 1.1

COMPONENT/RGB IN

Y/G

BNC terminal × 1

1.0 Vp-p (75 Ω) (with sync signal)

Pb/Cb/B

BNC terminal × 1

0.7 Vp-p (75 Ω) (without sync signal)

Pr/Cr/R

BNC terminal × 1

0.7 Vp-p (75 Ω) (without sync signal)

VIDEO IN

VIDEO

BNC terminal × 1

1.0 Vp-p (75 Ω)

Also used as Y/G terminal

PC IN

Mini D-sub 15 Pin (Compatible with DDC2B) × 1

Y/G:

1.0 Vp-p (75 Ω) (with sync signal)

0.7 Vp-p (75 Ω) (without sync signal)

Pb/Cb/B:

0.7 Vp-p (75 Ω) (without sync signal)

Pr/Cr/R:

0.7 Vp-p (75 Ω) (without sync signal)

HD/VD:

1.0 - 5.0 Vp-p (high impedance)

AUDIO1 IN

Stereo mini jack (M3) × 1, 0.5 Vrms

Shared with DVI-D IN and PC IN

AUDIO2 IN

Stereo mini jack (M3) × 1, 0.5 Vrms

Shared with COMPONENT/RGB IN and VIDEO IN

AUDIO OUT

Stereo mini jack (M3) × 1, 0.5 Vrms

Output: Variable (-∞ to 0 dB)

(1 kHz 0 dB input, 10 kΩ load)

SERIAL IN

External Control Terminal

D-sub 9 Pin × 1:

RS-232C compatible

SERIAL OUT

External Control Terminal

D-sub 9 Pin × 1:

RS-232C compatible

DIGITAL LINK/LAN

RJ45 × 1:

For RJ45 network connections, compatible with PjLink

Communication method:

RJ45 100BASE-TX

IR IN

Stereo mini jack (M3) × 1

IR OUT

Stereo mini jack (M3) × 1

USB

TYPE A USB connector × 1

DC 5V / 1A (USB 3.0 is not supported.)

Sound

Speakers

80 mm × 30 mm × 2 pcs

Audio Output

20 W [10 W + 10 W] (10 % THD)

Remote Control Transmitter

Power source

DC 3 V (battery (AAA/R03/UM4 type) × 2)

Operating range

Approx. 7 m (22.9 ft)

(when operated directly in front of remote control sensor)

Mass

Approx. 63 g / 2.22 oz (including batteries)

Dimensions (W × H × D)

44 mm × 105 mm × 20.5 mm /

1.74" × 4.14" × 0.81"

*1: Environmental temperature to use this unit at high altitudes (1 400 m (4 593 ft) and higher and below 2 800 m (9 186 ft) above sea level): 0 °C to 35 °C (32 °F to 95 °F)

*2: VIERA LINK is not supported.

Note

- Design and specifications are subject to change without notice. Mass and dimensions shown are approximate.

Software License

This product incorporates the following software:

- (1) the software developed independently by or for Panasonic Corporation,
- (2) the software owned by third party and licensed to Panasonic Corporation,
- (3) the software licensed under the GNU General Public License, Version 2.0 (GPL V2.0),
- (4) the software licensed under the GNU LESSER General Public License, Version 2.1 (LGPL V2.1), and/or
- (5) open source software other than the software licensed under the GPL V2.0 and/or LGPL V2.1.

The software categorized as (3) - (5) are distributed in the hope that it will be useful, but WITHOUT ANY WARRANTY, without even the implied warranty of MERCHANTABILITY or FITNESS FOR A PARTICULAR PURPOSE. For details, see the license conditions displayed by selecting [Software licenses], following the specified operation from the initial setting menu of this product.

At least three (3) years from delivery of this product, Panasonic will give to any third party who contacts us at the contact information provided below, for a charge no more than our cost of physically performing source code distribution, a complete machine-readable copy of the corresponding source code covered under GPL V2.0, LGPL V2.1 or the other licenses with the obligation to do so, as well as the respective copyright notice thereof.

Contact Information:

oss-cd-request@gg.jp.panasonic.com

Notice about AVC/VC-1/MPEG-4

This product is licensed under the AVC Patent Portfolio License, VC-1 Patent Portfolio License and MPEG-4 Visual Patent Portfolio License for the personal use of a consumer or other uses in which it does not receive remuneration to (i) encode video in compliance with the AVC Standard, VC-1 Standard and MPEG-4 Visual Standard ("AVC/VC-1/MPEG-4 Video") and/or (ii) decode AVC/VC-1/MPEG-4 Video that was encoded by a consumer engaged in a personal activity and/or was obtained from a video provider licensed to provide AVC/VC-1/MPEG-4 Video. No license is granted or shall be implied for any other use. Additional information may be obtained from MPEG LA, LLC. See <http://www.mpegla.com>.

(for the U.S.A and Puerto Rico)

Panasonic Solutions Company
Unit of Panasonic Corporation of
North America
Two Riverfront Plaza, Newark,
New Jersey 07102-5490

Panasonic Professional Flat Panel Display Limited Warranty

Panasonic Solutions Company. (referred to as “the Warrantor”) will repair this product and all included accessories with new or refurbished parts, free of charge in the USA or Puerto Rico, of the original purchase in the event of a defect in materials or workmanship as follows:

antenna, inadequate signal pickup, maladjustment of consumer controls, improper operation, power line surge, improper voltage supply, lighting damage, or service by anyone other than an authorized repair facility, or damage that is attributable to acts of God.

Models or Parts	Part Warranty	Labor Warranty
Professional Flat Panel Display	2 Years	2 Years

LIMITS AND EXCLUSIONS

There are no express warranties except as listed above.

On-site or carry-in service in the **USA and Puerto Rico** may be obtained during the warranty period by contacting Panasonic Solutions Company Service toll free at 1-877-655-2357.

THE WARRANTOR SHALL NOT BE LIABLE FOR INCIDENTAL OR CONSEQUENTIAL DAMAGES (INCLUDING, WITHOUT LIMITATION, DAMAGE TO DISCS) RESULTING FROM THE USE OF THIS PRODUCT, OR ARISING OUT OF ANY BREACH OF THE WARRANTY. ALL EXPRESS AND IMPLIED WARRANTIES, INCLUDING THE WARRANTIES OF MERCHANTABILITY AND FITNESS FOR PARTICULAR PURPOSE, ARE LIMITED TO THE APPLICABLE WARRANTY PERIOD SET FORTH ABOVE.

This warranty is extended only to the original purchaser and is non transferable. A purchase receipt or other proof of date of original purchase will be required before warranty service is rendered.

Some states do not allow the exclusion or limitation of incidental or consequential damages, or limitations on how long an implied warranty lasts, so the above exclusions or limitations may not apply to you. This warranty gives you specific legal rights and you may have other rights, which vary from state to state.

This warranty only covers failures due to defects in materials or workmanship, which occur during normal use. The warranty does not cover damage which occurs in shipment, or failures which are caused by products not supplied by the warrantor, or failures which result from improper installation, set-up adjustments, improper

If you have a problem with this product that is not handled to your satisfaction, then write the Consumer Affairs Department at the Company address indicated above.

In the USA and Puerto Rico
FOR SERVICE
CALL TOLL FREE
1-877-655-2357

Panasonic Canada Inc.
5770 Ambler Drive, Mississauga, Ontario L4W 2T3
LIMITED WARRANTY STATEMENT

Panasonic Canada Inc. (also known as PCI) warrants this product to be free of defects in material and workmanship under normal use during the applicable warranty coverage period described below. PCI agrees to repair, or at its option, exchange any part that becomes defective. However, the product must be purchased and serviced in Canada. The product or part that shows evidence of defect must be delivered prepaid or carried in to an authorized Panasonic Broadcast Service Center. This warranty does not cover shipping costs.

The warranty coverage period is one year for both parts and labour beginning with the date of original end user purchase, subject to the exceptions as stated below. Repaired or replacement parts supplied during the warranty coverage period carry the unexpired portion of the original warranty coverage period. Proof of product purchase is a condition of warranty service. The owner must produce the product purchase receipt or other satisfactory evidence of date of original purchase.

This warranty does not apply to external appearance items, such as handles, knobs, switches, The warranty does not apply to any parts or products of the product, installed, altered, repaired or replaced in any part. In the opinion of PCI, affects the reliability of or detracts from the performance of the product.

For products requiring routine preventive maintenance, that maintenance must be performed in order to maintain warranty coverage.

Serial numbers that have been altered, defaced or removed void this warranty. This warranty does not cover replacements or repairs necessitated by loss or damage resulting from any cause beyond the control of PCI.

Marking or related images (sometimes called "burn-in") resulting from the display of fixed images on video display products are not defects and are not covered under this warranty.

THIS EXPRESS, LIMITED WARRANTY IS IN LIEU OF ALL OTHER WARRANTIES, EXPRESS OR IMPLIED, INCLUDING ANY IMPLIED WARRANTIES OF MERCHANTABILITY AND FITNESS FOR A PARTICULAR PURPOSE. IN NO EVENT WILL PANASONIC CANADA INC. BE LIABLE FOR ANY SPECIAL, INDIRECT OR CONSEQUENTIAL DAMAGES.

In certain instances, some jurisdictions do not allow the exclusion or limitation of incidental or consequential damages, or the exclusion of implied warranties, so the above limitations and exclusions may not be applicable.

WARRANTY COVERAGE PERIOD EXCEPTIONS

Item	Parts	Labour
Video Tape	30 days—Replacement only (content not covered)	N/A
P2/SD Cards	(Content not covered)	N/A
Video Heads	1 year or 2,000 hrs. (whichever comes first)	1 year or 2,000 hrs. (whichever comes first)
D5 Video heads	1 year or 1,000 hrs. (whichever comes first)	1 year or 1,000 hrs. (whichever comes first)
Maintenance Items	90 days	90 days
Colour Camera CCD Imaging Block	2 years	2 years
All LCD Monitors	2 years (burn-in not covered)	2 years
* DLP™ Projectors	3 years (burn-in not covered)	3 years
* LCD Projectors above 2,500 ANSI Lumens	3 years or 17,000 hrs. (whichever comes first)	3 years or 17,000 hrs. (whichever comes first)
* LCD Projectors below 2,500 ANSI Lumens	3 years or 2,500 hrs. (whichever comes first)	3 years or 2,500 hrs. (whichever comes first)
Projector Lamps	3 years or 1,500 hrs. (whichever comes first)	3 years or 1,500 hrs. (whichever comes first)
All Plasma displays	50% of the rated lamp life or 1 year. (whichever comes first)	50% of the rated lamp life or 1 year. (whichever comes first)
103 inch Plasma displays	2 years (burn-in not covered)	2 years
Hard Drive Disk Unit	3 years (burn-in not covered)	3 years
	1 year plus balance (if any) of the original Manufacturer's Limited Warranty. (Content not covered)	1 year

* Dust, smoke, rental/staging environment and twenty-four/seven operation, dramatically decreases the interval between performances of routine preventive maintenance required to maintain this warranty coverage.

Warranty Service

If the product needs to be shipped for service, carefully pack (preferably in the original carton) and enclose a letter detailing the complaint. Send prepaid and adequately insured to the local authorized Panasonic Service Centre in your area or to Panasonic Technical Support and Product Services Department, 5770 Ambler Drive, Mississauga, Ontario, L4W 2T3. Shipping to the letter location requires a return authorization before shipment. No liability is assumed for loss or damage to the product while in transit.

Customer Service

Customer Service Directory

Obtain products information and operative assistant; localize the closer distributor or Service Center; buy spare parts and accessories by our web site to Latin American:

<http://www.lar.panasonic.com>

Also you may contact us directly by our Contact Center:

Panama	800-PANA (800-7262)
Colombia	01-8000-94PANA (01-8000-947262)
Ecuador	1800-PANASONIC (1800-726276)
Costa Rica	800-PANA737 (800-7262737)
El Salvador	800-PANA (800-7262)
Guatemala	1-801-811-PANA (1-801-811-7262)
Chile	800-390-602
	From a cell phone: 797-5000
Venezuela	800-PANA-800 (800-7262-800)
Uruguay	0-800-PANA (0-800-7262)
Peru	0-800-00-PANA (0-800-00726)
Argentina	0800-333-PANA (0800-333-7262) 0810-321-PANA (0810-321-7262)
Paraguay	800-11-PANA (800-11-7262)
Dominican Republic	809-200-8000

Mexico Service

To obtain information in the Republic of Mexico contact us at:

[email: atencion.clientes@mx.panasonic.com](mailto:atencion.clientes@mx.panasonic.com)

<http://www.panasonic.com.mx>

Or you may contact us in the next following phones numbers:

01800-VIP-PANA (01800-847-7262) - Interior

(55) 5000-1200 - Mexico D.F. and Metropolitan Area

Disposal of Old Equipment and Batteries

Only for European Union and countries with recycling systems



These symbols on the products, packaging, and/or accompanying documents mean that used electrical and electronic products and batteries must not be mixed with general household waste. For proper treatment, recovery and recycling of old products and used batteries, please take them to applicable collection points in accordance with your national legislation.

By disposing of them correctly, you will help to save valuable resources and prevent any potential negative effects on human health and the environment.

For more information about collection and recycling, please contact your local municipality. Penalties may be applicable for incorrect disposal of this waste, in accordance with national legislation.

EU



Note for the battery symbol (bottom symbol)

This symbol might be used in combination with a chemical symbol. In this case it complies with the requirement set by the Directive for the chemical involved.

Information on Disposal in other Countries outside the European Union

These symbols are only valid in the European Union.

If you wish to discard these items, please contact your local authorities or dealer and ask for the correct method of disposal.

Notice (U.S.A. only)

Disposal may be regulated in your community due to environmental considerations. For disposal or recycling information, please visit Panasonic website:

<http://www.panasonic.com/environmental>

or call 1-888-769-0149.

Customer's Record

The model number and serial number of this product may be found on its rear panel. You should note this serial number in the space provided below and retain this book, plus your purchase receipt, as a permanent record of your purchase to aid in identification in the event of theft or loss, and for Warranty Service purposes.

Model Number

Serial Number

For TH-55SF1HU, TH-49SF1HU and TH-42SF1HU

Panasonic System Communications Company of North America

Unit of Panasonic Corporation of North America

Executive Office :

Two Riverfront Plaza, Newark, New Jersey 07102-5490

Panasonic Canada Inc.

5770 Ambler Drive
Mississauga, Ontario
L4W 2T3

For TH-55SF1HW, TH-49SF1HW and TH-42SF1HW

Panasonic Testing Centre
Panasonic Service Europe, a division of Panasonic Marketing Europe GmbH
Winsbergring 15, 22525 Hamburg, F.R. Germany

Panasonic Corporation

Web Site: <http://panasonic.com>

English